

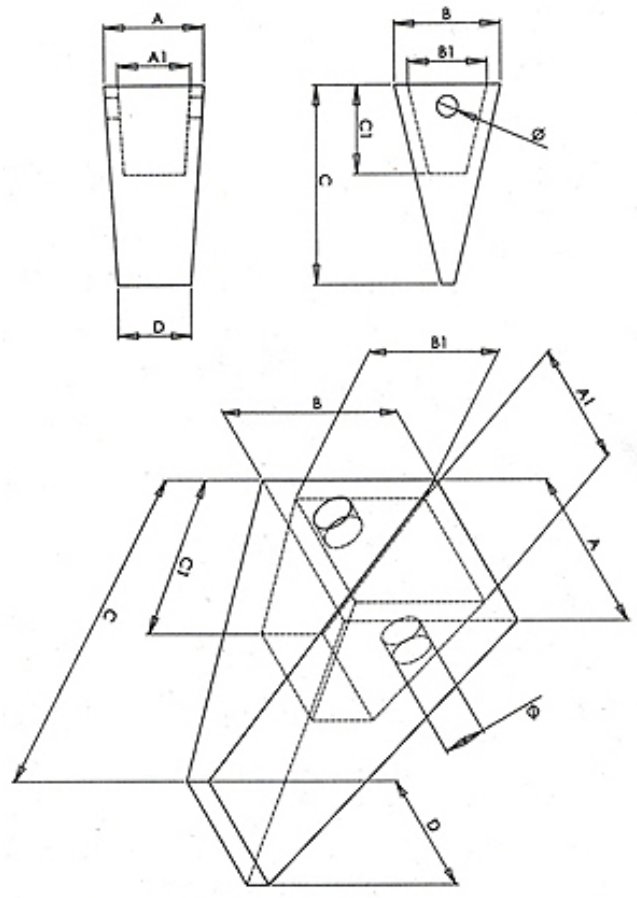

























Drawing : Adapter(mm)





Drawing : Tooth (mm)

P/N	TYPE	Model	U/W KG	A/ mm	B/mm	C/mm	D/mm	A1/mm	B1/mm	C1/mm	holes	Stock qty	Picture
18S	Tooth	DH55	1										
18SA(20mm)	Adapter	DH55	1.5	54.6	46.3	159		44	34.4	66	8.5		
S130	Tooth	DH130	3.4	84	91	193	83	63	68	91	20.5		
2713-1222 (30mm)	Adapter	DH130	5.8	84	87	297		58	66	88	19		

2713-9041 (OLD)	Tooth	DH220	5.9	102	107	236	85	72.5	78	111	23	
DH220 (40mm) (OLD)	Adapter	DH220	9.1	100	106	326		57.4	78.3	104	22.8	
2713Y1217 (H) (NEW)	Tooth	DH220	6.1	98.7	99	225	98	73	71	106	23	
2713Y1217-1 (L) (NEW)	Tooth	DH220	5.2	99	97	218	99	72.5	70	109	23.5	
2713Y1217RC (NEW)	Rock chisel	DH220	5.6	100	92.5	238	38	72.5	64	105	23	
2713-1218 (35mm)	Adapter	DH220	8.9	99.3	101	334		64	72	98	21	
2713-1218 (40mm)	Adapter	DH220	8.5	99	101	334		64	72	98	21	
2713Y1219 713-00027	Tooth	DH280	7.2	110	108	240	109	81	77	114	25.6	
2713Y1219RC	Rock chisel	DH280	7.1	111	107	257	43	81	76	114	25	
2713-1220 3T1220 (40mm)	Adapter	DH280	11.4	107	107	355		68	79	110	21	
2713-1220 3T1220(45mm)	Adapter	DH280	10.9	106	107	356		68	79	110	21	

713-00032	Tooth	DH360	9.4	129	127	271	121	96.7	95	126	25.7	
713-00032RC	Rock chisel	DH360	9.3									
2713-00033 (50mm)	Adapter	DH360	17.4	127	120	395		76.4	95.5	125	23.5	
2713-00033 (55mm)	Adapter	DH360	16.8	127	120	395		76.5	95.3	125	23.5	
2713-1236 713-00029	Tooth	DH420	17.4	148	142	311	144	110	106	140	28.5	
2713-1273 (50mm)	Adapter	DH420	24.1	143	137	440		109	108	135	26	
DH55R (Big holes)	Side cutter	DH55	1.8	100	32	150					19	
DH55L (big holes)	Side cutter	DH55	1.8	100	32	150					19	
38S R	Side cutter	JINAN SPE.	1.5	110	26	180					17.5	
38S L	Side cutter	JINAN SPE.	1.5	110	26	180					17.5	
36-SCR	Side cutter	DH55	1.7	108	19	218					13.8	

36-SCL	Side cutter	DH55	1.7	108	19	218					13.8		
DH220R	Side cutter	DH220	15.8	290	62	430					24.5		
DH220L	Side cutter	DH220	15.8	290	62	430					24.5		