

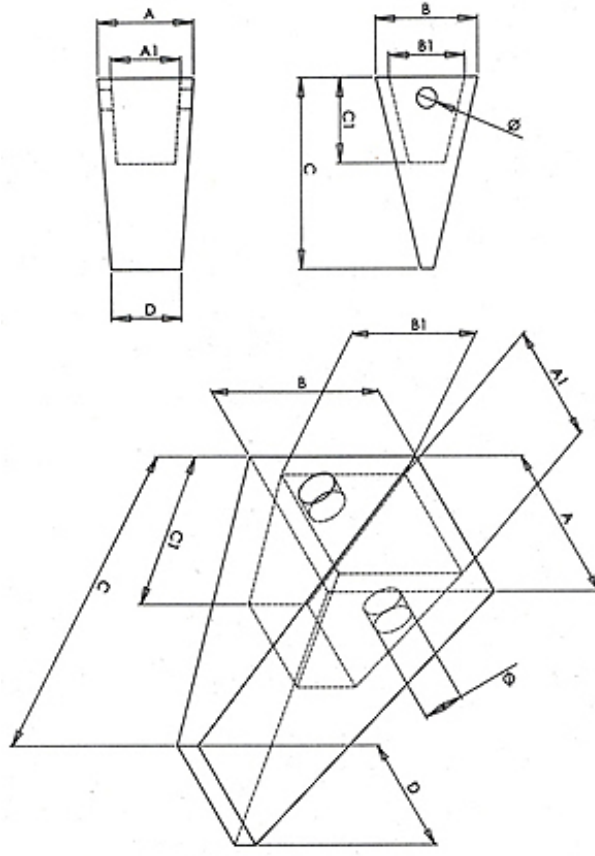











Drawing : Adapter(mm)



Drawing : Tooth (mm)

P/N	TYPE	Model	U/W KG	A /mm	B/mm	C/mm	D/mm	A1/mm	B1/mm	C1/mm	holes	Stock qty	Picture
25T	Drilling Tooth		2.2	80	74	180	64	62	57	83	11.5		
25T	Adapter		3.25	69	70	193		61	56	81	13		
25S	Tooth	25S	2.1	79	75	178	59	63	55	89	11		
3806-25 (25mm)	Adapter	25S	4.7	73	82	268		61	54	87	11		
30S	Tooth	30S	2.5	91	74	182	72	76	59	85	12		

25-30 (30mm)	Adapter	30S	5.1	89	79	280		71	55	85	11		
35S	Tooth	35S	4.3	107	96	211	92	88	68	102	11.5		
157-35 (35mm)	Adapter	35S	9.6	103	97	345		81	67	100	13		
3803-35 (10mm)	Adapter	35S	7	104	90	320		80	60	102	13		
40S	Tooth	40S	7.1	123	102	250	95	98	81	117	16.5		
3809-40 (40mm)	Adapter	40S	14.1	120	106	410		95	82	113	15.5		
25-30PN	PIN	30S	0.1	20	9	74							