

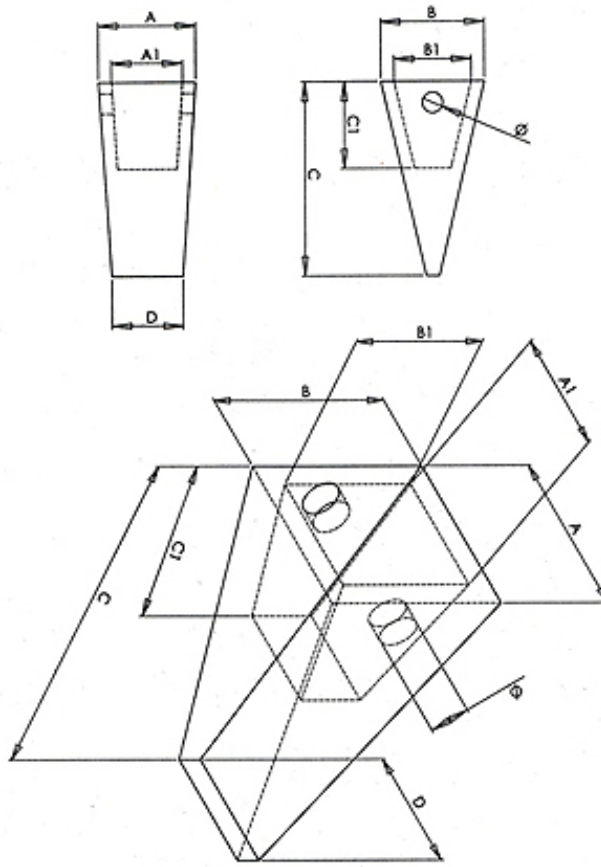







Drawing : Adapter(mm)



Drawing : Tooth (mm)

P/N	TYPE	Model	U/W KG	A /mm	B/mm	C/mm	D/mm	A1/mm	B1/mm	C1/mm	holes	Stock qty	Picture
TB-00394	Tooth	EX60	2.2	74	71	179	55.4	56.3	53	77.4	24.8		
20X-70-14151	Adapter	EX60/70	2.8										
021S1	Tooth	EX70	2.7	63	81	170	57	47	58	72	17		
EX70(25mm)	Adapter	EX70	2.9										
TB00705	Tooth	EX200	8.9	115	120	232	100	80	82	110	28		

TB00822	Tooth	EX350	12	139	127	239	122	99	90	125	26	
EX200R	Side cutter	EX200	13.1	298	58	425					24	
EX200L	Side cutter	EX200	13.1	298	58	425					24	