

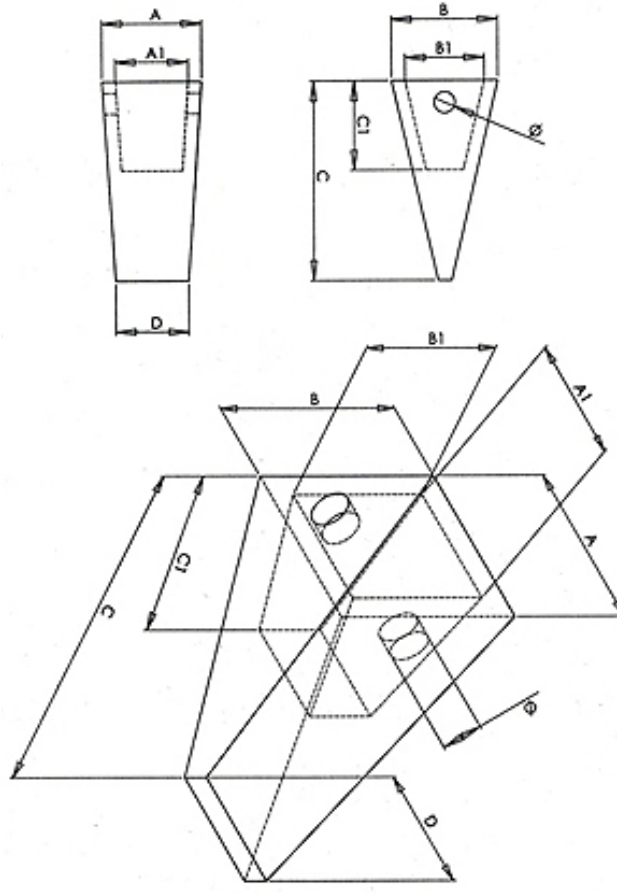











Drawing : Adapter(mm)

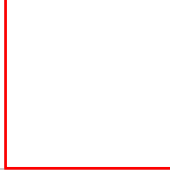

Drawing : Tooth (mm)

P/N	TYPE	Model	U/W KG	A /mm	B/mm	C/mm	D/mm	A1/mm	B1/mm	C1/mm	holes	Stock qty	Picture
E161-3027	Tooth	HY200	4.3	95	82	220	87	71	59	95	25.5		
E161-3027RC	Rock chisel	HY200	4.8	97	89	233	39	72	58	95	25		
E161-3017 (30mm)	Adapter	HY200	7.1	103	89	292		70	58	93	20		
E262-3046	Tooth	HY290	6.75	116	109	254	90	88	78	121	26		

E262-3046RC	Rock chisel	HY290	7.4	113	108	289	42	87	78	120	25	
E262-3027 (40mm)	Adapter	HY290	11.7	109	103	365		86	77	113	21.5	
6IE7-0101	Tooth	R450	9.8									
6IE7-0100	Adapter	R450	14.9									
CLZ-01-DR	Side cutter	HY60	2.9	151	24	270					18.5	
CLZ-01-DL	Side cutter	HY60	2.9	151	24	270					18.5	
6IE3R	Side cutter	HY200	16.2	325	56	370					26.5	
6IE3L	Side cutter	HY200	16.2	325	56	370					26.5	