

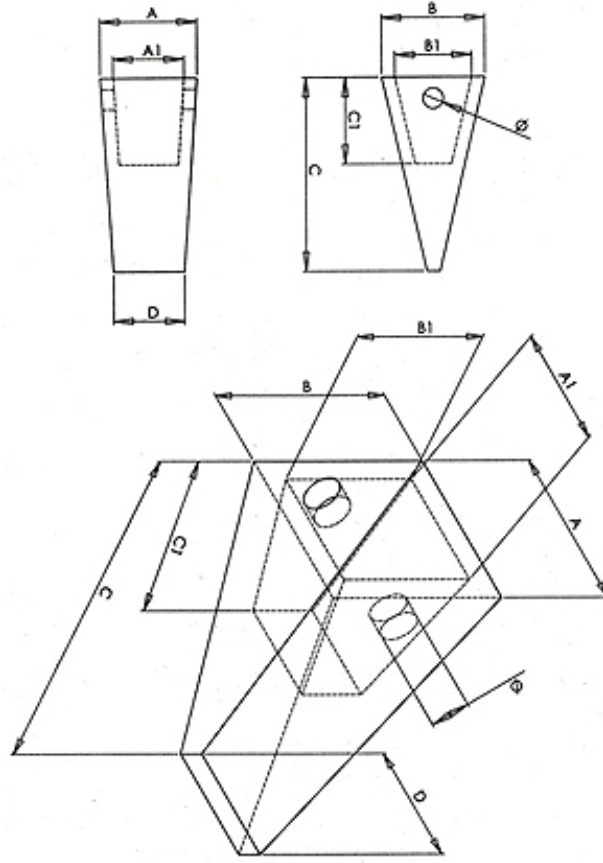







Drawing : Adapter(mm)



Drawing : Tooth (mm)

P/N	TYPE	Model	U/W KG	A /mm	B/mm	C/mm	D/mm	A1/mm	B1/mm	C1/mm	holes	Stock qty	Picture
ZL-50C	Tooth	Liugong 50	4.9/6.9	90	97	220	91	70	68	77	23.5		
T40-50	Tooth	Liugong 50	6.3										
Liugong50	Adapter	Liugong 50	9.9										
CG30	Tooth		3.8										
CU-YC85R	Side cutter	YC85	5.2	238	44	293					23.5		

CU-YC85L	Side cutter	YC85	5.2	238	44	293					23.5		
210	Tooth		5										
210 (30mm)	Adapter		6.6										
E303	Tooth		27.5										
6399.1	Adapter		8.3										